

HURRICANE DAILY

1.880 SPECIAL BUILD





Finally a precision tool for everyday use



Side guard individually adjusted to the seat position

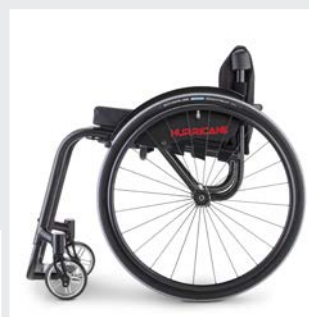

Precise form

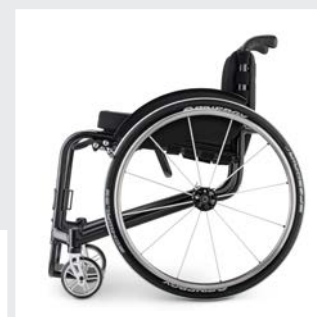

Extremely stable

A precision tool for everyday use

COST EFFECTIVENESS

- highly durable and extremely stable thanks to fully welded frame with huge material strength
- Perfect balance of stability and weight

THERAPEUTIC BENEFITS

- A fixed-dimensions wheelchair with an open or closed frame; precise customisation to the individual measurements and needs of the user
- a lot of weight saved by welded seat height, back and seat angle
- the chassis can also be customised exactly to certain needs, thereby providing the best possible mobility
- everyday rehabilitative goals and sporting activities are aided by the combination of weight saving, brilliant stability and precisely tailored customisation for perfect mobility and an optimal sitting position

APPLICATIONS

- active wheelchair for users with high demands when it comes to weight and mobility
- for the active wheelchair user in everyday life

ORDER/SPECIAL BUILD QUOTATION

Please fax your completed order form to: +49 (0) 5733 922 9311 Customer service: +49 (0) 5733 922 311

Invoice address / customer no.:
Delivery address:
Consignment / remarks:



HURRICANE DAILY 1.880 SPECIAL BUILD

All prices exclude VAT at the statutory rate. Valid from 01.01.2019 to 31.12.2019.

Our general terms and conditions apply, which can be found on www.meyra.de/en/gtc.

Achtung!

Beim Transport in öffentlichen Verkehrsmitteln (z.B. Zug) können die Abmessungen des Rollstuhles über den Richtwerten der Transportunternehmen liegen. Bitte erkundigen Sie sich im Vorfeld.

01 Determining wheelchair dimensions

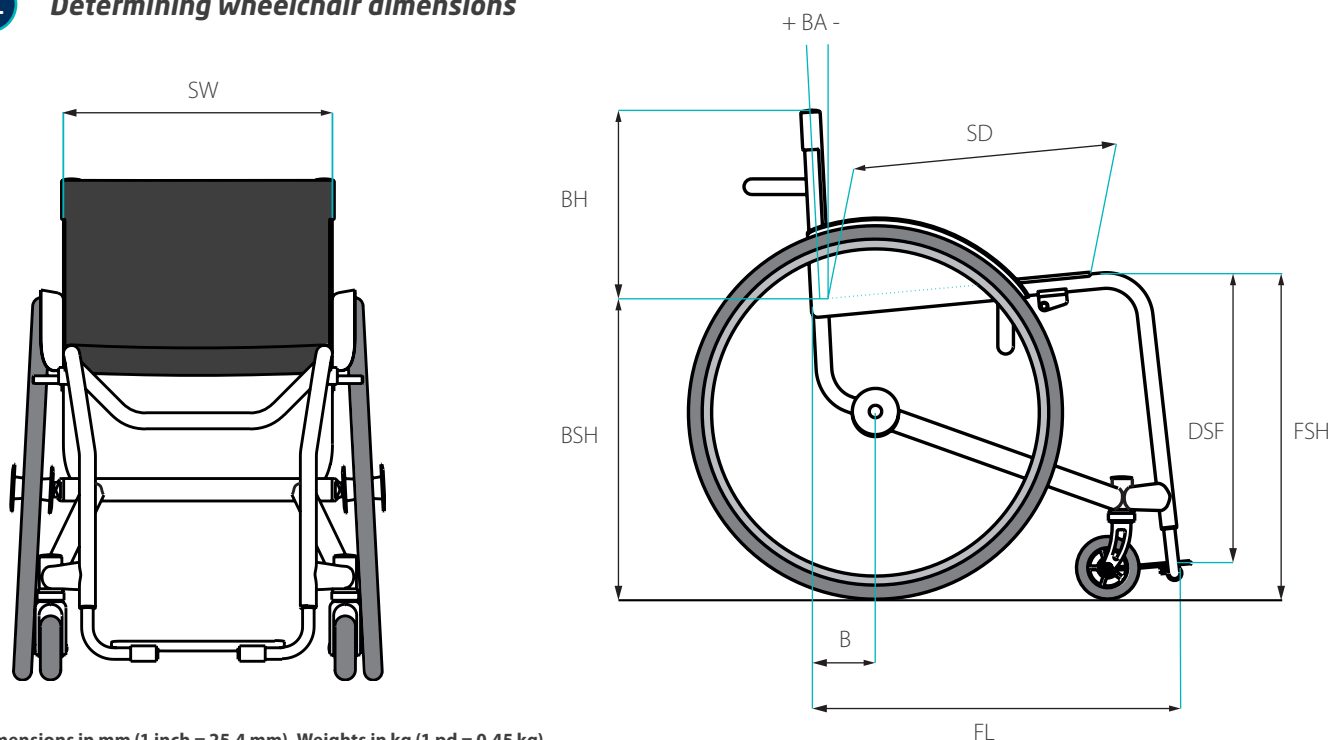

Dimensions in mm (1 inch = 25,4 mm), Weights in kg (1 pd = 0,45 kg),
Speed in km/h (1 mph = 1,61 km/h), Tolerance ± 10 mm / 0,39 inch
The specifications are subject to constructional changes.

Please tick your choice in the boxes

Standard version: In case you do not make another selection we will generally deliver the standard version.

00 Rahmenform (Rahmenlänge)

CODE	BEZEICHNUNG
<input type="checkbox"/> 347	Everyday version special active wheelchair made-to-measure with open S-frame, incl. 25 mm tapered frame per side, up to 100 kg client weight
<input type="checkbox"/> 348	Everyday version special active wheelchair made-to-measure, incl. 25 mm tapered frame per side up to 150 kg client weight
<input type="checkbox"/> 4950	Tapered frame acc. to specification
<input type="checkbox"/> 600	Seat angle ergonomically adjusted
<input type="checkbox"/>	Employee number:
<input type="checkbox"/> 3918	Without fitting*
<input type="checkbox"/> 3920	Upon request fitting at MEYRA or sporting event (additional charge may appear*, extended delivery time)
<input type="checkbox"/> 55700	Upon request precise fitting by MEYRA specialist (appointment to be arranged)
<input type="checkbox"/> 3921	Upon request fitting at dealer (additional charge may appear extended delivery time)

* pre-assembly, if necessary shipping, disassembly

01 Determining wheelchair dimensions

			DESCRIPTION	Specify the desired dimensions exactly to the mm:
B*	Axle position	mm	Horizontal centre rear wheel to rear edge of back tube in height of the seat tube	
FL*	Frame length	mm	Horizontal front edge of legrest tube to rear edge of back tube in height of the seat tube	
SW*	Seat width	mm	From one seat tube outer edge to the other	
SD*	Seat depth	mm	Front edge of back tube to very front point of seat surface	
BSH*	Back seat height	mm	From ground to seat tube upper edge rear	
FSH*	Front seat height	mm	From ground to seat tube upper edge front	
CSH	Central seat height	mm	Only in combination with ergonomic seat angle CODE 600	
C	Seat position	mm	Only in combination with ergonomic seat angle CODE 600	
	Frame insert	mm		
SL*	Distance FSH to footplate	mm	Vertical seat tube upper edge to upper edge footplate	
BH*	Back height	mm		
BA*	Backrest angle	Degrees	Without specification 90° standard vertical from ground, please note +/- dimension	

* These measures are necessary for the 3D configurator

New:
3D configurator

From now on you can view your Hurricane Everyday/ Hurricane S in advance by 3D image.

Please tick your choice in the boxes

Standard version: In case you do not make another selection we will generally deliver the standard version.

02

Seat- and back system Backstrap

CODE	DESCRIPTION
<input type="checkbox"/> 235	Seat and back upholstery black color
<input type="checkbox"/> 292	Back upholstery, anatomically adjustable tension with straps, breathable

Backrest options

CODE	DESCRIPTION
<input type="checkbox"/> 411	Without push handles
<input type="checkbox"/> 413	Push handles short, fixed, anatomically molded
<input type="checkbox"/> 141	Push handles, swing-away
<input type="checkbox"/> 3001	Backrest fold-down onto the seat, only in combination with flip-up side guard CODE 3002

Seat cushion (material and colours as back)

<input type="checkbox"/> 739	Seat cushion	30 mm	Soft
<input type="checkbox"/> 740	Seat cushion	50 mm	Soft
<input type="checkbox"/> 719	Seat cushion	30 mm	Hard
<input type="checkbox"/> 720	Seat cushion	50 mm	Hard

03

Castors

CODE	DESCRIPTION	RIM	TYRES	Ø X W
<input type="checkbox"/> 151	Castor (pair)	Plastic	Solid rubber	100 x 23 mm
<input type="checkbox"/> 325	Castor (pair)	Plastic	Solid rubber	125 x 30 mm
<input type="checkbox"/> 327	Castor (pair)	Plastic	Soft solid rubber	142 x 37 mm
<input type="checkbox"/> 143	Castor (pair)	Plastic	Puncture-proof	150 x 32 mm

Upon request also smaller castors available, please ask for those sizes!

Please tick your choice in the boxes

Standard version: In case you do not make another selection we will generally deliver the standard version.

Xtrends castors

CODE	ARTIKEL	BEZEICHNUNG	FELGE	BEREIFUNG	Ø X B	
<input type="checkbox"/>	689	1068963	Lightwheel (pair)	plastic	Solid rubber transparent / coloured	100 x 22 mm
<input type="checkbox"/>	689	1072385	Castor (pair)	Alu silver	Solid rubber	100 x 32 mm
<input type="checkbox"/>	689	1072386	Castor (pair)	Alu silver	Solid rubber	125 x 32 mm
<input type="checkbox"/>	689	1079523	Frog legs castor "Storm"	Alu silver	Solid rubber	100 x 32 mm
<input type="checkbox"/>	689	1079524	Frog legs castor "Storm"	Alu black	Solid rubber	100 x 32 mm
<input type="checkbox"/>	689	1079525	Frog legs castor "Storm"	Alu silver	Solid rubber	125 x 32 mm
<input type="checkbox"/>	689	1079526	Frog legs castor "Storm"	Alu black	Solid rubber	125 x 32 mm
<input type="checkbox"/>	689	Frog legs castor (pair) <input type="checkbox"/> silver 1081340 <input type="checkbox"/> black 1081341 <input type="checkbox"/> orange 1081342 <input type="checkbox"/> red 1081343 <input type="checkbox"/> blue 1081344 <input type="checkbox"/> white 1083736		Solid rubber	100 x 36 mm	
<input type="checkbox"/>	689	Frog legs castor (pair) <input type="checkbox"/> silver 1081345 <input type="checkbox"/> black 1081346 <input type="checkbox"/> orange 1081347 <input type="checkbox"/> red 1081348 <input type="checkbox"/> blue 1081349 <input type="checkbox"/> white 1083737		Solid rubber	125 x 36 mm	

04 Rear wheels (type)

CODE	DESCRIPTION	Ø	Ø
<input type="checkbox"/>	651 SILVERDESIGN with radial spokes and large flange hub incl. quick-release axle (pair)	24"	-
<input type="checkbox"/>	695 Active wheel , reinforced, with radial spokes, large flange hub, hollow rim in black (pair). Recommended for more than 100 kg client weight or dynamic driving style!	24"	-
<input type="checkbox"/>	4964 Spinergy wheel, 12 black 4 mm spokes, (white and orange spokes on request at additional costs)	24"	-

Xtrends rear wheels (Further wheel types on request at additional costs)

CODE	ARTICLE	DESCRIPTION	Ø	
<input type="checkbox"/>	688	1075478	Active wheel, reinforced, with radial spokes, large flange hub, hollow rim in black, incl. Marathon Plus Evolution and premium steel handrim (pair). Recommended for more than 100 kg client weight or dynamic driving style!	25" x 1"
<input type="checkbox"/>	688	1075479	Active wheel, reinforced, with radial spokes, large flange hub, hollow rim in black, incl. Marathon Plus Evolution and premium steel handrim (pair). Recommended for more than 100 kg client weight or dynamic driving style!	26" x 1"
<input type="checkbox"/>	688	1068707	CROSS wheel incl. aluminium rim, coarse lug tyres and premium steel handrim (pair)	24" x 1,75"
<input type="checkbox"/>	688	1068712	Ultra Light incl. 8 bar high pressure tyres and alu handrim (pair)	24" x 1"
<input type="checkbox"/>	688	1068713	Black Light incl. Marathon Plus Evolution und aluminium handrim (Paar)	24 x 1"
<input type="checkbox"/>	688	<input type="checkbox"/> blue 1080426	New active-wheel with radial spokes, Schwalbe ONE tires, hub, rim and pushing rim colored	24 x 1"
<input type="checkbox"/>		<input type="checkbox"/> red 1080427		
<input type="checkbox"/>		<input type="checkbox"/> gold 1080428		
<input type="checkbox"/>		<input type="checkbox"/> black 1080420		
<input type="checkbox"/>	688	<input type="checkbox"/> metallic blue 1080421	Lightweight magnesium wheel, radial spokes, large flange hub, hollow rim colored, Schwalbe ONE tires and aluminum pushing rim in black	24 x 1"
<input type="checkbox"/>		<input type="checkbox"/> metallic red 1080422		
<input type="checkbox"/>		<input type="checkbox"/> white 1080423		
<input type="checkbox"/>		<input type="checkbox"/> metallic orange 1080424		

Rear wheel size

<input type="checkbox"/>	61	Rear wheels	24"
--------------------------	----	-------------	-----

Rear wheel options
Wheel camber

<input type="checkbox"/>	478	1°-Wheel camber
<input type="checkbox"/>	907	3°-Wheel camber
<input type="checkbox"/>	454	6°-Wheel camber
<input type="checkbox"/>	470	Another wheel camber <input type="text"/> Degrees on request

Wheel base extension

<input type="checkbox"/>	899	Wheel base extension <input type="text"/> mm Dimension as specified just in combination with CODE 348
--------------------------	-----	---

Please tick your choice in the boxes

Standard version: In case you do not make another selection we will generally deliver the standard version.

05 Handrims and handrim options

CODE	DESCRIPTION	Ø
<input type="checkbox"/> 493	Premium steel high polished	24"
<input type="checkbox"/> 168	Optigrip special handrim for tetraplegics, black rubber-coated	24"
<input type="checkbox"/> 445	Titanium, with 6 fixtures	24"
<input type="checkbox"/> 849	Curve L, aluminium black anodized, ergonomic rear wheel profi, H 31 mm, just in combination with active wheel CODE 695 and Spinerger-wheel CODE 4964	
<input type="checkbox"/> 850	Curve L Tetra Grip, anti-slip coated, aluminium, suitable for tetraplegics, ergonomic rear wheel profil, H 31 mm, just in combination with active wheel CODE 695 and Spinerger-wheel CODE 4964	
<input type="checkbox"/> 853	GEKKO, aluminium black anodized with changeable rupper lip, ergonomic rear wheel profile, H 31 mm, just in combination with Active wheel CODE 695 and Spinerger 1073641, 1073640	
<input type="checkbox"/> 692	Handrim space 15 mm	24"
<input type="checkbox"/> 693	Handrim space 25 mm	24"

06 Tyres

CODE	DESCRIPTION	Ø
<input type="checkbox"/> 496	High pressure tyres 8 bar	24 x 1"
<input type="checkbox"/> 897	Marathon Plus Evolution tyres, protected against breakdowns	24 x 1"
<input type="checkbox"/> 363	Schwalbe ONE tires, without profile, protected against breakdowns	24 x 1"

Hinweis: Reifen bestehen aus einer Gummimischung, die auf einigen Untergründen bleibende oder schwer entfernbare Spuren hinterlassen können (z. B. Kunststoff-, Holz- oder Parkettfußböden, Teppiche, Auslegeware).

Für Schäden durch Abrieb an den Untergründen können wir keine Haftung übernehmen.

07 Brakes

CODE	DESCRIPTION
<input type="checkbox"/> 305	Pressure brake for driver
<input type="checkbox"/> 2595	"Light" pressure break, made of aluminium, swing away

08 Side guards and armrests

Please note the marked functional features!

1 = welded 2 = screwed 3 = swing-up 4 = covering the wheel

CODE	DESCRIPTION	1	2	3	4
<input type="checkbox"/> 100	Side guard made of aluminium, incl. wheel cover	-	●	-	●
<input type="checkbox"/> 3002	Side guard made of aluminium, swing-up, only in combination with folddown back CODE 3001	-	●	●	●
<input type="checkbox"/> 101	Side guard made of aluminium, incl. wheel cover (welded)	●	-	-	●
<input type="checkbox"/> 783	Carbon side guard	●	-	-	●

Please tick your choice in the boxes

Standard version: In case you do not make another selection we will generally deliver the standard version.

09 Footrests

↑ height adjustable ↻ angle adjustable

CODE	DESCRIPTION
<input type="checkbox"/> 311	Tubular footrest made of aluminium
<input type="checkbox"/> 315	Tubular footrest made of aluminium, incl. aluminium footplate
<input type="checkbox"/> 3003	Tubular footrest made of aluminium, incl. aluminium footplate, height and angle adjustable

10 Wheelchair accessories Hand and spoke guar

CODE	DESCRIPTION
<input type="checkbox"/> 490	Transparent (Hurricane the original)

Anti-tip-wheels

<input type="checkbox"/> 713	Anti-tip-wheel, swing-away, mounted right
<input type="checkbox"/> 691	Anti-tip-wheels, swing-away (1 pair, recommended)

Other accessories

<input type="checkbox"/> 359	Snap-on calf strap, made of plastic, reinforced not in combination with S-frame CODE 347
<input type="checkbox"/> 261519600	Wheelcase "Black Wheel Case", fits max. 2 x 24" wheels or 1 x 25"/ 26" wheel
<input type="checkbox"/> 597	Padded leg protection for decubitus prophylaxis

11 Frame colours

CODE	DESCRIPTION
<input type="checkbox"/> 176	Aluminium, nature
<input type="checkbox"/> 130	Titanium grey
<input type="checkbox"/> 2185	Brown metallic
<input type="checkbox"/> 206	Matte black
<input type="checkbox"/> 216	Deep black
<input type="checkbox"/> 4023	Signalwhite
<input type="checkbox"/> 227	Red metallic
<input type="checkbox"/> 183	Silver metallic
<input type="checkbox"/> 4922	Green metallic
<input type="checkbox"/> 4923	Orange metallic

Further frame colours can be selected on request at extra cost! Please have a look at the colour chart in the catalogue preface!

Date:	Signature:
-------	------------



02

CODE 141



03

Article 1072385



03

Article 1081342

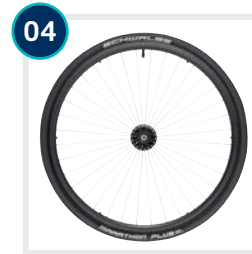

04

CODE 695

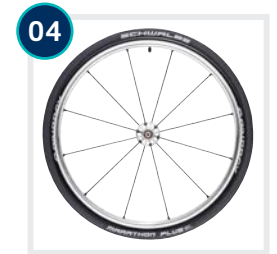

04

CODE 4964

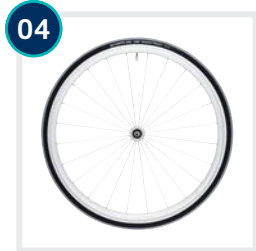

04

Article 1068712

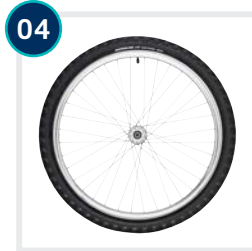

04

Article 1068707

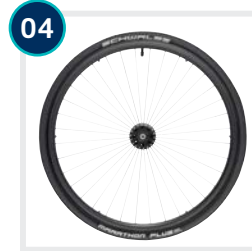

04

Article 1075478

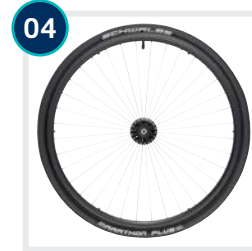

04

Article 1075479

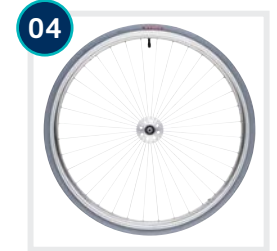

04

CODE 651



05

CODE 849



05

CODE 850



04

Article 1081358

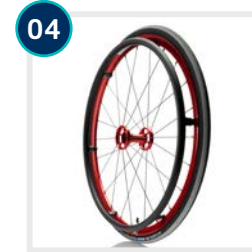

04

Article 1081359

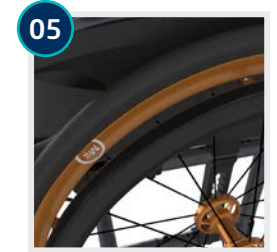

05

CODE 853



07

CODE 2595



08

CODE 100



08

CODE 3002



10

CODE 597



10

CODE 490

1. GENERAL – SCOPE

1.1. The following General Terms and Conditions of Delivery and Trade (GTC) for MEYRA GmbH shall apply to all contracts concluded with customers of the company. They shall also apply to all future transactions with the customer, even in the absence of a separate new agreement.

1.2. The customer shall accept that the General Terms and Conditions of MEYRA GmbH are binding on the present contract and also on all future contracts. Terms and conditions of the customer or third party shall not apply. MEYRA GmbH shall not be subject to such terms and conditions, even if they are not expressly excluded in individual cases.

1.3. These General Terms and Conditions shall only apply if the customer is an entrepreneur (s. 14 of the German Civil CODE), a legal entity under public law or a separate fund under public law.

2. OFFER, CONCLUSION OF CONTRACT

2.1. Offers from MEYRA GmbH are subject to confirmation and non-binding unless expressly designated as binding.

2.2. MEYRA GmbH may accept orders or commissions from the customer within 14 days of receipt with an offer confirmation in text form.

2.3. The contract shall be concluded by means of the offer confirmation in text form; this shall also apply to any changes or additions to the orders.

2.4. We retain our rights of ownership and copyright with respect to all documents delivered to the customer in association with placing of the order. These documents may not be disclosed to third parties without our express written consent. Should we not accept the customer's offer within the period stipulated in section 2.2, these documents are to be returned to us without delay.

3. PRICES

3.1. Prices are calculated exclusively in euros. All prices are net prices. Value added tax at the respective statutory rate is to be paid in addition.

3.2. Unless otherwise stated to the contrary in writing, our prices are ex works, excluding packing and shipping. The costs of packing and shipping shall be invoiced separately.

3.3. Insofar as list prices are used as a basis, the price list valid at the time the order is placed shall apply. Price changes shall be permitted if there is a gap of more than four months between conclusion of the contract and the agreed delivery date. Should salaries or material costs increase in the period up to completion, we shall be entitled to increase the price appropriately in accordance with the cost increases. The customer shall be entitled to withdraw from the contract only if the price increase significantly exceeds the increase in the general cost of living between the time of the order and of delivery.

3.4. In follow-up orders, MEYRA GmbH shall not be held to the prices in a previous contract.

3.5. Should the order value fall below a limit of € 150.00 net goods value, a minimum-order surcharge of € 9.50 including freight component shall be levied.

4. SHIPMENT, PASSING OF RISK

4.1. The place of delivery shall be the registered premises of MEYRA GmbH insofar as nothing has been expressly agreed to the contrary.

4.2. If the goods are shipped to the customer at this location, the risk of accidental loss or accidental deterioration of the goods shall transfer to the customer as soon as the goods (including partial deliveries) have been handed over to the charge of the third party responsible for shipping. This shall apply irrespective of whether the goods are shipped from the place of performance or who bears the freight costs.

4.3. Should claims for transport damage or losses be asserted against MEYRA GmbH, the customer must note the damage on the shipping documents or, in the event of losses, create a record without delay which is to be shown to us within one week.

4.4. Insurance against transport damage shall only be taken out at the express request and expense of the customer.

4.5. In the event of delayed handover or shipping for which the customer is responsible, the risk shall pass to the customer upon notification of the shipment's readiness for shipping.

4.6. Should there be no special instructions from the customer, the choice of transport route and means of transport shall be made by MEYRA GmbH without warranty and liability for the cheapest and fastest shipping method.

5. DATE OF DELIVERY / SCOPE OF DELIVERY

5.1. Proposed delivery periods shall be understood to be probable delivery dates, unless a particular date has been expressly established in writing.

5.2. If the parties have agreed a delivery period, this shall commence from the date of the order confirmation. The delivery period shall be deemed to have been observed if, prior to its expiration, the goods have left the plant or their readiness for shipping has been communicated.

5.3. Compliance with agreed delivery and performance dates requires the timely receipt of all documentation to be provided by the customer as well as the timely provision of all necessary information and the fulfilment of all other obligations by the customer. Should these conditions not be fulfilled in good time, the periods shall be extended appropriately.

5.4. MEYRA GmbH shall not be liable for delays in delivery due to force majeure or other events which, at the time the contract was concluded, were unforeseeable (e.g. strike, operational breakdown, delayed internal supply, transport delay, unfavourable weather, etc.) for which it is not responsible. The delivery period shall be extended for the duration of the obstacle to performance for which MEYRA GmbH is not responsible, plus a reasonable recovery period.

5.5. Should the resulting delay exceed a period of six weeks, both parties shall have the right to withdraw from the contract with regard to the scope of performance.

5.6. MEYRA GmbH shall be entitled to make partial deliveries provided that the partial delivery can be used by the customer within the scope of the contractual provision, the delivery of the remaining goods is guaranteed and the customer does not incur any additional costs as a result.

6. PAYMENT

6.1. Invoice amounts shall be paid in full within 30 days of receipt of the invoice into one of the bank accounts stipulated by us. However, where the invoice is not for the delivery of spare parts or repairs, the customer shall be entitled to a discount of 2% if payment is made within eight days of receipt of the invoice.

6.2. Cheques and bills shall only be accepted with express agreement. Acceptance is conditional on performance. Invoice corrections via cheques and bills are subject to payment. Values are taken on the day on which we finally have the proceeds at our disposal.

6.3. Should the customer fail to make the payment on the due date, any outstanding amounts shall be subject to interest at 8% above the respective base rate per annum. We reserve the right to enforce higher damages due to a delay in payment.

6.4. Should the customer default on payment, then all other receivables arising from the same legal

relationship shall immediately become payable without the need for a separate communication.

6.5. The customer shall only be entitled to offset in the event that its counterclaims have been legally established or are undisputed. The customer shall only be entitled to exercise a right of retention insofar as its counterclaim is based on the same contractual relationship.

6.6. MEYRA GmbH shall be entitled to assign its claims from deliveries and services.

7. RETENTION OF TITLE

7.1. The goods supplied by MEYRA GmbH shall remain the property of MEYRA GmbH until full payment of all present and future claims against the customer.

7.2. The customer may sell the reserved goods in the ordinary course of business. It is not entitled to make other disposals, in particular chattel mortgages and pledges. The claims of the customer arising from the resale of the reserved goods (including other receivables such as insurance claims or tort claims for loss or damage) shall be assigned to MEYRA GmbH by way of security. MEYRA GmbH shall accept the assignment. The customer shall be entitled to collect the assigned claim as long as it fulfils its payment obligations. In the event that it defaults on payment, we shall be entitled to revoke the collection authorisation.

7.3. Should the reserved goods be processed by the customer, it is hereby agreed that the processing shall take place in the name of and at the cost of MEYRA GmbH as the manufacturer and that it shall immediately acquire ownership or – if the processing is carried out using or in connection with materials from several owners or the value of the processed item is greater than the value of the delivered goods – co-ownership (fractional ownership) of the newly created item in the ratio of the value of the delivered goods to the value of the newly created item. Should MEYRA GmbH lose its ownership through consolidation or commingling or if, in the case of processing, it is not the owner of the delivered goods, the customer shall transfer to MEYRA GmbH in advance an appropriate co-ownership share in the new item equivalent to the proportionate value of the delivered item. MEYRA GmbH shall hereby accept the offer. The delivery shall be replaced by a gratuitous deposit.

7.4. The customer shall be obliged to notify us immediately of access by third parties to the goods delivered under retention of title and to provide us with the information and hand over the documentation required to enforce our rights. At the same time, the customer is to inform the third party without being asked of MEYRA GmbH's ownership. Any costs incurred from this shall be borne by the customer.

7.5. MEYRA GmbH shall be obliged to release the securities due to it at the request of the customer insofar as they exceed the value of the secured claims by more than 20%. The selection of the securities to be released is incumbent upon MEYRA GmbH.

7.6. In the event of a bankruptcy petition relating to the customer, we shall now prohibit the resale or processing of our reserved goods and shall revoke our collection authorisation with respect to the claims assigned to us.

7.7. In the event of delayed payment by the customer, we shall be entitled to demand the immediate return of the reserved goods.

8. WARRANTY / LIABILITY

8.1. The customer must inspect the delivered goods immediately upon delivery. Insofar as it relates to obvious defects or defects that would have been found during a thorough inspection, the customer

must notify us in writing of any complaints within one week of receipt of delivery. After expiry of this period, any liability for such defects is excluded. In the event of concealed defects, warranty claims shall only be valid if we are notified in writing within one week of discovery.

8.2. In cases of defective delivery, we shall have the right to choose to repair the defective item or to replace the defective item with a new delivery. The customer is obliged to provide us the defective product delivered free for inspection and repair. Should the repair or replacement delivery be unsuccessful, should they not be undertaken with a reasonable period or should we refuse to undertake them, the customer may withdraw from the contract or reduce the purchase price. A deadline shall not be required in those cases where it is not required by law.

8.3. The warranty shall be void if the customer modifies the delivery item without our consent or it is changed by a third party and it therefore becomes impossible or unreasonably difficult to rectify the defect. However, in each case, the customer must bear the additional costs resulting from the rectification of the defect.

8.4. The above regulations shall not affect any warranty that we assume on the part of the first user of the rehabilitation equipment.

8.5. Excluded from the warranty is the function-related wear of all items, modules, batteries and spare parts supplied by us as well as the inappropriate or improper storage, use or handling of the products.

8.6. Further claims by the customer, in particular for damages instead of performance and for reparation of any direct or indirect damage – including incidental or consequential damages, irrespective of the legal grounds – shall be excluded. This shall not be the case if MEYRA GmbH has concealed a legal or material defect maliciously or the damage is due to intent or gross negligence on the part of MEYRA GmbH, its legal representatives or vicarious agents or to any negligent breach of essential contractual obligations. Essential contractual obligations are understood to be those where their fulfilment enables the proper execution of the contract and on compliance with which the contracting parties regularly rely or may rely. In the case of damage to property and assets due to negligence, the liability of MEYRA GmbH shall however be restricted to an amount foreseeable in a typical contract. Furthermore, personal injury or damage to health caused by a breach of duty on the part of MEYRA GmbH, its legal representatives or vicarious agents are not excluded.

8.7. Liability under the *Produkthaftungsgesetz* [German Product Liability Act] is unaffected.

9. STATUTE OF LIMITATIONS

Claims by the customer relating to defects shall have a limitation period of two years from handover / delivery of the goods to the customer. With respect to replacement items and repairs, the limitation period shall be one year from handover / delivery of the goods to the customer. Excluded from this are claims for damages due to endangerment of life, personal injury or health and / or claims arising out of damages caused by gross negligence or intent on the part of MEYRA GmbH or its vicarious agents. In such instances, the statutory limitation periods shall apply.

9.1. REPLACEMENT PRODUCT SERVICE

Independent of the warranty, MEYRA GmbH offers customers the opportunity to exchange a defective product for a refurbished product. The following provisions shall apply to the products offered as replacements:

- Replacement products are refurbished and technically in order.
- The defective product must be returned free of charge to MEYRA GmbH within 15 working days.

The returned item shall become our property.

- Should the defective product not be returned, we shall invoice the customer for the replacement item at 95% of the sales price for a new product.
- The returned item must correspond to the replacement product in model and design. The product must also be reusable and may only show wear and tear commensurate with normal use.
- MEYRA GmbH shall determine whether the returned item fulfils the requirements specified above. Should these requirements not be fulfilled, we shall also issue the customer with an invoice for the amount specified above for the replacement product delivered less the residual value of the returned item.

10. PRODUCT SAFETY GUARANTEE

10.1. PRODUCT RECALL

If, due to defects in the goods delivered or to existing legal stipulations, it becomes necessary to have a product recalled, then the Client is obliged to cooperate in implementing such product recall in order to ensure that it can be conducted efficiently. In the event of a product recall, the Client is in particular obliged to inform MEYRA GmbH regarding the whereabouts of the delivery items in the delivery chain (from the Client to end consumer). To this end, the Client must continually document, using appropriate documentation methods, the progress of the goods and provide MEYRA GmbH with such documentation upon request. If the Client supplies the goods to resellers, then it must impose upon such resellers, via contractual provisions, the foregoing duties of cooperation intended to ensure the efficient implementation of a product recall.

10.2. The Client is obliged to have end customers instructed with regard to the handling and use of the delivered products and to have such instruction carried out by trained specialists. If the Client supplies the goods to resellers, then it must impose upon such resellers, via contractual provisions, the foregoing training obligations pertaining to the handling and use of the delivered goods.

11. LIABILITY FOR DESIGN CHANGES

It is important to note that more stringent legal provisions shall apply in the case of custom orders. Design changes to MEYRA GmbH products by the customer or a third party contracted by the customer shall only be permitted if they are in line with the safety requirements and our management has declared its consent in writing in advance. To this end, if requested, a modified model and design drawings are to be made available to us. Should design changes be undertaken without the prior written consent of our management and damage due to the changes is caused to a third party for which we are liable in the external relationship, the customer shall be required to release us in the internal relationship from claims by the third party.

12A. RETURN OF FINISHED PRODUCTS AND MODULES

Goods returned without an accompanying delivery note or invoice copy shall not be accepted. Credit equivalent to 80 % of the net value of the goods shall be granted for goods returned in their original packaging and in mint condition. Excluded from return are items delivered more than three months ago, custom orders, sanitary items, filled batteries and products with a net value of less than € 100.00. Also excluded are custom-made wheelchairs (e.g.: wheelchairs for children or adaptive wheelchairs). The transport risk shall be borne by the sender.

12B. ORDER CANCELLATIONS FOR FINISHED PRODUCTS

12B.1. Order cancellations without the prior agreement of MEYRA GmbH shall not be permitted.

12B.2. Cancellations shall be made in writing.

12B.3. Should an agreement be reached regarding the cancellation of finished products which are ready for delivery, the following shall apply:

- Rehabilitation products shall be credited in full.

In principle, orders for custom wheelchairs and sports wheelchairs cannot be cancelled.

- In the event of the cancellation of an order for adaptive wheelchairs, 20% of the net value shall be retained to cover costs.

The cancellation fee for electric wheelchairs and scooters is 5%. The cancellation fee for standard and lightweight wheelchairs is 10%.

12C. COLLECTION / DISPOSAL

Our prices do not include the costs for collection and disposal of complete old equipment from users other than private households. On request, and against reimbursement of the costs incurred, we are able to organise the collection and recycling / disposal of such equipment, provided it was purchased from us. Returns without the prior agreement of MEYRA GmbH are not possible.

13. USE OF PERSONAL DATA

We shall be entitled to save and process internally any personal data of the customer falling within the scope of the statutory provisions, in particular the General Data Protection regulation.

14. JURISDICTION, APPLICABLE LAW, SEVERABILITY CLAUSE

14.1. Unless expressly agreed to the contrary, the place of performance shall be the premises of MEYRA GmbH in Kalletal-Kalldorf.

14.2. The jurisdiction for all disputes arising out of the contractual relationship shall be determined by our headquarters in Kalletal-Kalldorf. We shall also be entitled to take action against the customer within its jurisdiction.

14.3. The law of the Federal Republic of Germany shall apply excluding the UN Convention on Contracts for the International Sale of Goods.

14.4. Should individual provisions of these General Terms and Conditions be wholly or partially void or ineffective, the validity of the remaining provisions shall remain unaffected.